

Framtidens Aktivhus AS

et firma i Ligaard-gruppen

Future Active House Norway



Future Active House

Vision: Solutions to share



Societies all over the world face the same challenges: to make the demands of modern life meet the need for protection of the environment, to make advanced technology integrate with good living conditions and closeness to nature.

Future Active House seeks to meet these challenges. Based on the Active House principles, the building is designed to be both a showcase of innovative solutions as well as a modern family home. The idea of creating such a building emerged as a collaborative project between Tore Ligaard as and VELUX A/S.

Tore Ligaard, founder and owner of the company bearing his name, was unsatisfied with the standard of energy-efficient buildings. In his opinion, they often sacrificed factors such as daylight and indoor air quality in order to meet the energy requirements,

"This was very much against my personal preference after nearly fifty years in the industry. Fresh air creates well-being as well as mental health. So the Active House principles seemed very appealing," he explains.

He soon brought together a team of partners who shared his views. Today, their visions have come true.

A number of manufacturers and suppliers have contributed to the Future Active House. Framtidens Aktivhus as, a subsidiary of the Ligaard Group, manages the construction; the VELUX Group, besides being the supplier of roof windows, sun screens, blinds and solar collectors, also gives its support by providing tools such as the VELUX Daylight Visualizer. NTNU, the Norwegian University of Science and Technology, provides advice and consultancy. Husbanken, the Norwegian State Housing Bank, supports the project financially.

"The Future Active House project is very much in line with our purpose: to encourage initiatives with high ambitions and creative solutions," says Senior Advisor Gry Kongfli of Husbanken.

Her colleague Birger Jensen adds that private companies play an important role in the efforts to mainstream the use of environment-friendly solutions:

"Because they have their eye on the demands from the market, private companies can push progression forward".

Location: Future Active House is located near Trondheim, Norway. The region is surrounded by mountains and located about 600 km from the Arctic Circle. The weather ranges from mild, light summers to winters of heavy snowfall and long nights. Trondheim is also a vibrant area, with a growing and young population. This all adds up to an excellent location for a project with the ambition to prove how energy efficiency is compatible with values of light, air and closeness to nature.

The plot of the Future Active House is on a south-facing mountainside in the village of Stjørdal. From the house, residents overlook the Trondheim fjord and enjoy proximity to golf courses, shopping centres and airport. Careful design and state-of-the-art technology provide the house with a healthy and comfortable indoor climate, while the extensive use of windows allows residents to enjoy the benefits of daylight from all directions. Insulation, solar collectors and a compact design help keep the house's energy consumption to a minimum.

Energy-efficient buildings present a number of challenges. Apparent solutions like extensive use of insulation and a south-oriented window area can have negative consequences for the indoor climate and living environment. The Active House principles take a holistic view of the interaction between energy, indoor climate and environment. The aim is to show that energy efficiency is compatible with a healthy and comfortable living environment, and to create a home that enables the residents to make active use of the surrounding nature and local community.

The initiatives include:

- solar collectors on facades provide hot water and heating
- a combination of windows and climate control technology ensures natural ventilation, pleasant indoor temperatures and good air quality
- building materials that are mostly available through Do-It-Yourself outlets. Local and regional materials are preferred whenever possible. It is the aim of the project to show that the concept can be adapted to regional conditions
- extensive use of windows in both roof and walls enables the residents to enjoy the surrounding nature and make use of the daylight and solar heat.

Future Active House strives to create and test solutions that are applicable to new constructions as well as existing buildings. But if the solutions are going to have a wider impact, they need not only to be smart but also affordable and easy to operate. An important part of the Future Active House project is the systematic collection of data and user experiences in order to improve and evaluate the house and its use. Through guided tours, information material and mass media, the partners behind Future Active House will communicate the achieved knowledge of the project to the building industry and the wider public.





A sustainable future is based on both the visions of today and the experiences of the past. Future Active House draws on traditional Norwegian architecture and modern solutions. The aim is to create a house in which both technology and atmosphere can serve as inspiration to the future. Welcome inside.

Architecture: Nordic light

A house designed for the future should strive to be timeless; that is the vision of Geir Brendeland, one of the architects behind Future Active House. Together with colleague Olav Kristoffersen, he has developed and designed the house in close cooperation with energy consultants. The challenge was to create a house where architecture is added to energy efficiency, without sacrificing the qualities of light, air and interaction with the environment.

"We wanted the house to have a strict, modern, Nordic attitude on the outside, but to be bright and colourful on the inside," Brendeland explains. In their attempt, the architects draw on inspiration from both past and present.

"The ground floor is the private zone, with bedrooms and the big bathroom. The main room on the

first floor is essential and inspired by traditional Norwegian architecture, where houses often have a large, central room with light coming in from a hole in the roof. That creates an incredible atmosphere," says Geir Brendeland, adding that the benefits of a large main room are not just aesthetic:

"Common spaces have some timeless qualities. You have more choices when it comes to furniture and activities."

With the ambition of combining the best of past and present technology, the architects used facade windows and roof windows that face all four corners of the world. Brendeland explains.

"When there is light coming from all directions, the residents can sense the progression of the day. They can feel the rhythm of nature and seasons."

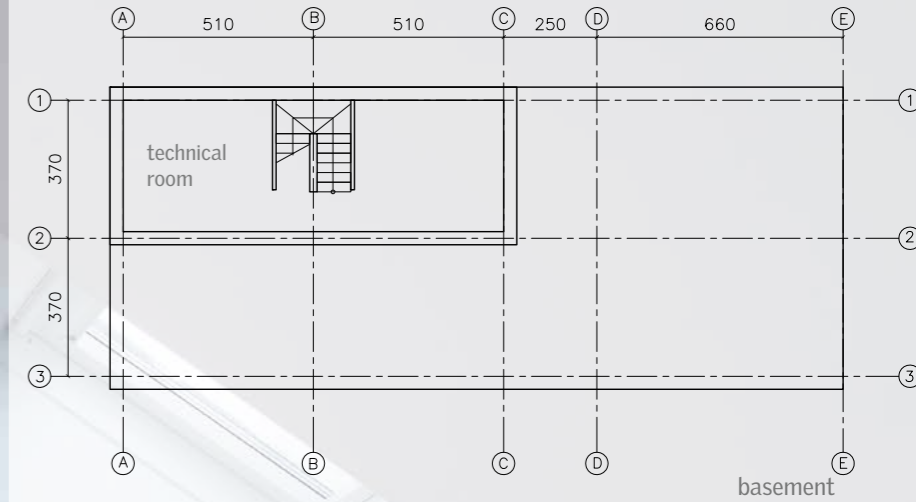

He thinks that being able to interact with the environment is important, but that urbanisation creates challenges in terms of balancing this contact with the residents' need for space, peace and privacy. Buildings for the future need to take this problem into account.

"Future Active House is an energy-efficient concept as well as an ex-

ample of how to build compact, low buildings in a densely populated area," Brendeland explains.

He hopes that both the aesthetic and technological visions will inspire future constructions. "The house itself is made for this specific client, but we believe it is a concept that many people would find attractive," concludes Geir Brendeland.

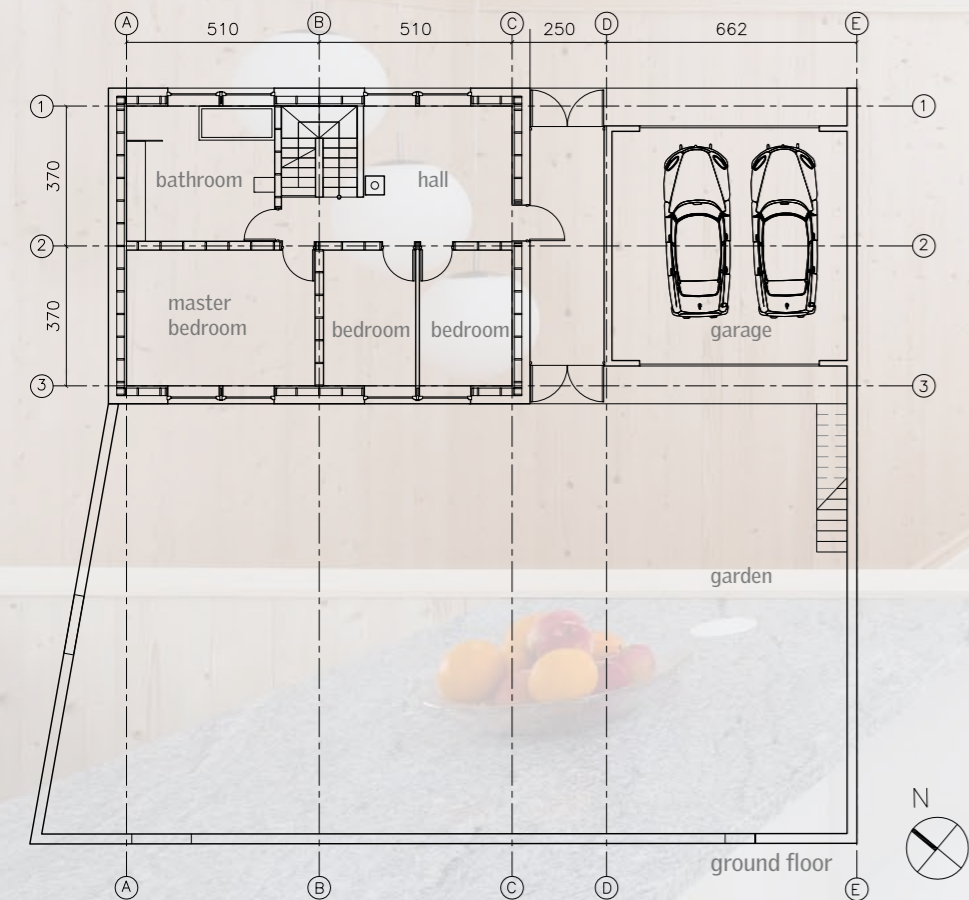
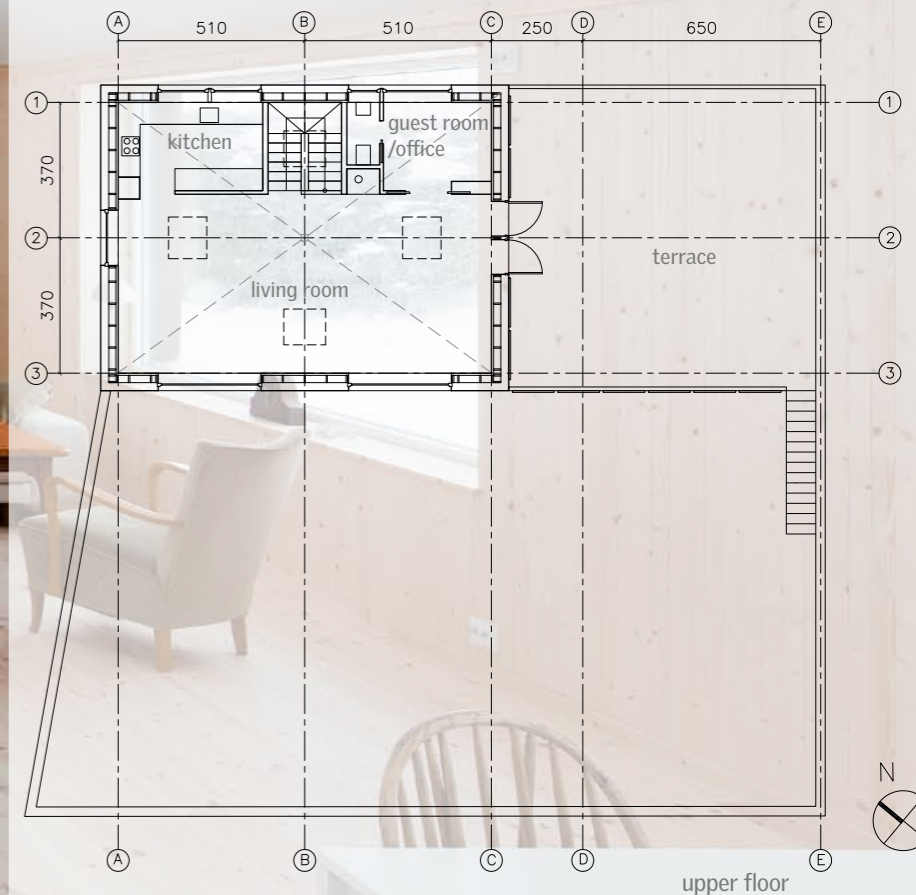

Solution: Low energy, high performance

Future Active House makes use of several energy-saving technologies, while sticking to architectural ideals of daylight, good air quality and a pleasant living environment. Professor and architect Anne Grete Hestnes of NTNU, the Norwegian University of Science and Technology, has provided advice and consultancy in the construction process:

"I highlighted some general principles of energy use in buildings. For example, it is not that hard to reduce the energy consumption needed for heating, but hot water is a challenge. You cannot just use insulation to solve the problem of supplying hot water. You need equipment like solar collectors or heat pumps."

As a result of her advice, Future Active House makes extensive use of solar collectors, with an area of 18.5 m².

Other energy saving initiatives include

- natural ventilation
- automatically controlled roof windows and four facade windows
- sunscreens preventing overheating on hot days and heat loss in colder times
- user friendly control of the indoor climate through touch panels
- LED lighting
- thick insulation in roof, walls and floor
- low-emission wood stove and fire insert contributing to the heating
- extensive use of wood, a renewable material



Vision

Active House is a vision of buildings that create healthier and more comfortable lives for their occupants without impacting negatively on the climate – moving us towards a cleaner, healthier and safer world.

The Active House vision defines highly ambitious long term goals for the future building stock. The purpose of the vision is to unite interested parties based on a balanced and holistic approach to building design and performance, and to facilitate cooperation on e.g. building projects,

product development, research initiatives and performance targets that can move us further towards the vision.

Active House proposes a target framework for how to design and renovate buildings that contribute positively to human health and well-being by focusing on the indoor and outdoor environment and the use of renewable energy. An Active House is evaluated on the basis of the interaction between energy consumption, indoor climate conditions and impact on the external environment.

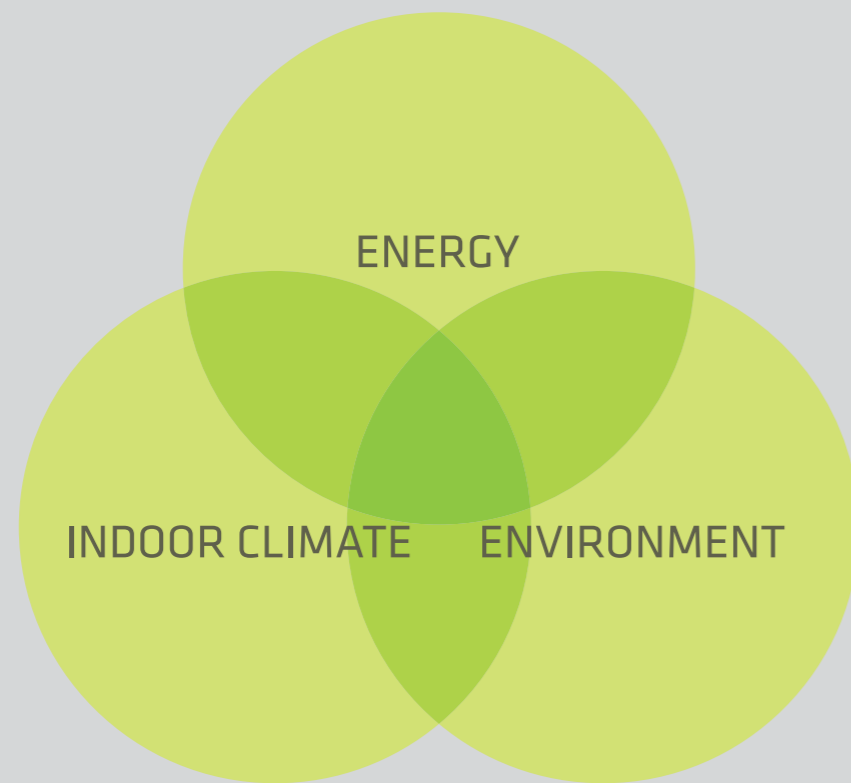

Energy – Contributes positively to the energy balance of the building

An Active House is energy efficient and all energy needed is supplied by renewable energy sources integrated in the building or from the nearby collective energy system and electricity grid.

Indoor Climate – Creates a healthier and more comfortable life

An Active House creates healthier and more comfortable indoor conditions for the occupants and the building ensures a generous supply of daylight and fresh air. Materials used have a positive impact on comfort and indoor climate.

Environment – Has a positive impact on the environment

An Active House interacts positively with the environment by means of an optimised relationship with the local context, focused use of resources and on its overall environmental impact throughout its life cycle.

Key principles of Active House

An important aspect of the Active House concept is that of 'integration'. Although Energy, Indoor climate and Environment are essential components of the vision, it is the way their integration promotes architectural quality, human health, comfort and well-being which represents the value of the building.



Energy

- A building which is energy efficient and easy to operate
- A building which substantially exceeds the statutory minimum in terms of energy efficiency
- A building which exploits a variety of energy sources integrated in the overall design

Indoor climate

- An indoor climate that promotes health, comfort and the sense of well-being
- A building which ensures good indoor air quality, adequate thermal climate and appropriate visual and acoustical comfort
- An indoor climate which is easy for the occupants to control and at the same time encourages responsible environmental behavior

Environment

- A building which exerts the minimum impact on environmental and cultural resources
- A building which avoids ecological damage and seeks to add to local biodiversity
- A building which is constructed of materials which have high recycled content and which provides the ability for its own recycling or re-use

Integration of the three main principles of energy, indoor climate and environment

- A building which integrates the demands of comfort, climate, energy, environment and ecology into an attractive whole
- A building where such integration adds to the architectural quality and human well-being
- A building whose interactive systems and spaces add to human enjoyment and support environmentally responsive family life

Active House is an initiative supported by the VELUX Group

Energy: Half the consumption of a normal house



heating sources in the house

A comfortable and healthy home requires an extensive supply of energy. Future Active House includes a range of energy-efficient technologies following a two-way strategy: to minimise energy consumption while maximising the role of renewable sources in energy supply. The house will be classified with energy rating A, which means its annual consumption must not be more than 79 kWh per square metre. An average detached house in Norway consumes approximately 170 kWh per square metre a year – older detached houses consumes up to 300 kWh.

"Energy consumption in Future Active House is kept low thanks to a number of initiatives," explains energy consultant Johnny Holst:

"Low-energy windows are crucial because the window area is so big. The insulation of the roof and walls is also very important."

Future Active House is able to have an unusually large facade window area thanks to a solution provided by the window producer NorDan. Marketing Director Johannes Rasmussen of NorDan explains:

"In terms of energy, the weakest parts of a window are the frame and sash. By putting high performance insulation in the frame, we are able to create windows with a very low U-value. Indirectly, the quality of the frame affects the transparency of the glass. Because the frame is so well insulated, NorDan is able to use glass with a better transparency than most low-energy glass."

He points out that poor window glass quality has implications for the total energy consumption of a house: "The darker the rooms, the more artificial light you need."

Other focus areas in the Future Active House are heating, electricity, hot water and automatic control of building equipment.

Heating:

Future Active House has several heating sources. Solar collectors provide energy to a hydronic heating system in the entrance area and bathroom.

Secondary heating sources are a Jøtul fireplace on the ground floor and a fire insert on the first floor. In cold spells, wood burning will ensure a pleasant indoor temperature and help prevent over-consumption of electricity, though electrical heating must be possible in winter.

In the cold season, electricity will be connected with the energy-efficient heater from Oso, supplying domestic hot water. Electrical heating cables are installed in the floors in the corridor and bathroom.

Hot water:

Solar collectors are installed on the south-east facade and on part of the balcony railings. They will meet approximately 50% of the requirement for domestic hot water. In the summer, the house will be almost self-

sufficient in hot water, but during the coldest winter it will require some additional electrically heated hot water.

Low energy electrical system:

Vintervoll has designed the electrical solutions for Future Active House. Low-energy LED lighting and a user-friendly, energy-saving automatic control system are the core of the electrical installations in the house.

Automatic monitoring and control:

Future Active House is equipped with a KNX system from Instell, which monitors and manages building equipment and functions such as sunscreens, ventilation and temperature control. Correct operation and control can bring significant energy savings (40-60%) to all these functions. In winter, the heat recovery system, provided by Swegon, recovers more than 80% of the heat from the exhaust air (more information at page 16-17).



Ventilation: Stay fresh, keep warm

Good air quality creates an immediate sense of well-being. The Active House principles recommend a combination of natural and mechanical ventilation in order to achieve good indoor air quality. However, ventilation and the consequent heating of fresh, cold air can require large amounts of energy. Future Active House seeks to overcome this problem by introducing a number of energy-saving technologies. It is possible to allow fresh air to produce an indoor climate that is pleasant and healthy, at the same time as keeping energy loss to a minimum.

Automatic control of windows:

in Future Active House, four facade windows and four roof windows will be under automatic control. Based on air quality data from sensors monitoring humidity, temperature and CO₂ levels in the house, the roof windows will open and close automatically. This solution has several benefits; it allows for an energy-saving combination of natural and mechanical ventilation, a so-called hybrid ventilation system and it ensures optimum quality of the indoor air.

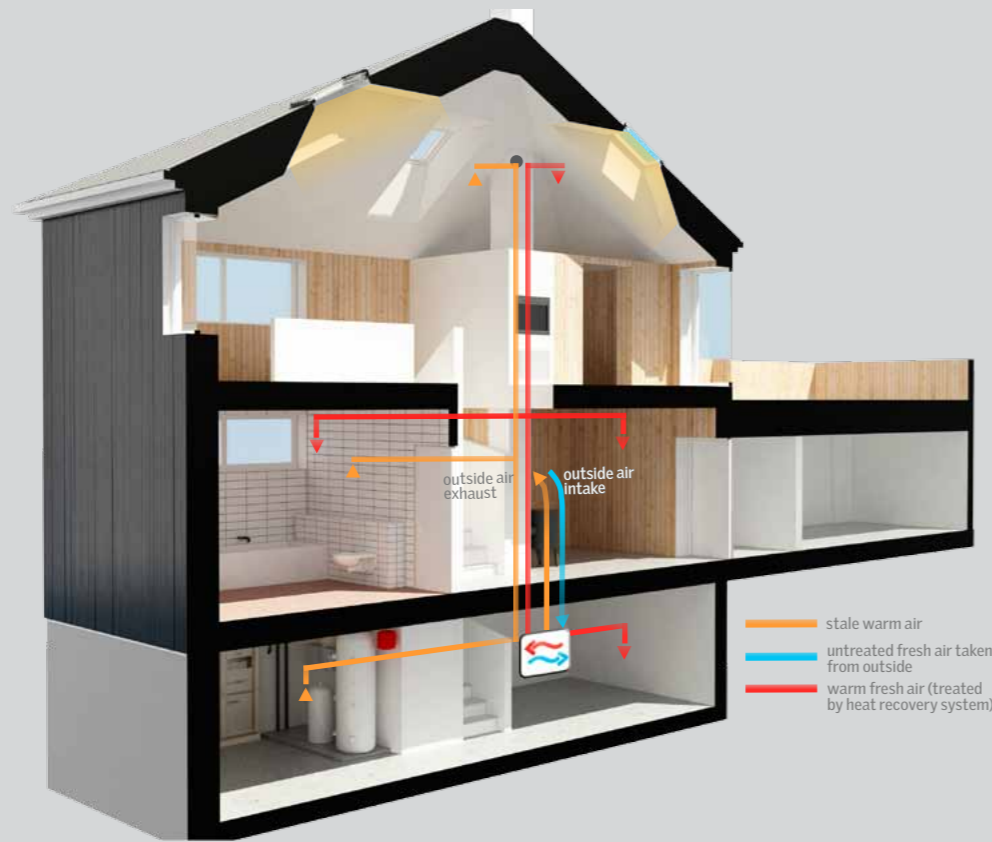

In the winter, mechanical ventilation will take fresh outdoor air into the house and pre-heat it in a heat exchanger (using a heat recovery system), thereby reducing the energy required for warming cold air.

Natural ventilation: Put the air at work



During summer natural ventilation ensures that the house is cooled and fresh air supplied in a way that significantly reduces the demand for electric fans. Furthermore, openable windows are appreciated by most users in the warm part of the year.

A building with poor ventilation resembles a closed box; it prevents the home from breathing and depreciates the living conditions of the residents. Natural ventilation can overcome many problems caused by poor air quality. By making use of natural air change, particles and humidity will be let out of the house, which will, consequently, feel fresh and inviting. With a built-in flap on the VELUX roof windows it is possible to ventilate the room without having to leave the windows open.

If roof windows are installed in the ridge, it is, furthermore, possible to ventilate the house in a few minutes by making use of the stack effect. If you open the roof window simultaneously with a facade window, the air will be changed in no time. The house will stay warm, as thermal energy is stored in the building materials.

Climate control responding to activity:

The ventilating unit is connected to the control system and regulated according to the activity in the house. If the occupants are out, the unit will go into saving mode. Hygrostats in the bathroom and wet rooms increase ventilation under high humidity conditions.

Ventilation adapted to the well insulated building:

Swegon and Aas Luftbehandling, responsible for the installations, have included several components in the project to tackle the special conditions of a highly insulated building structure.

The following components are fitted to the unit and the ventilating system:

- Fireplace switch ensures that when a fireplace is lit, air input is compensated for a given time. This reduces the negative air pressure in the house, optimises the chimney draught and prevents smoke from coming into the room.
- Low pressure compensator is installed in external outlets such as the kitchen ventilator. A pressure sensor is placed in a channel above the ventilator. When the ventilator is switched on during cooking activities, the air input of the aggregate is increased and the output is reduced to help compensate for low pressure

- A switch at the entrance allows the residents to turn ventilation to a minimum when the house is not occupied.

- Air exhauster on the roof has been prepared and a hood fitted. An extra air exhauster can facilitate additional intake of fresh air on hot days. It can also ensure quicker and controlled cooling of the house in case of rising temperatures caused by fireplaces or increased activity. The decision about an extra air exhauster will be taken when the house has been monitored and tested for some months.

- Acoustic silencer reduces noise from the fan.



Control system: Hands on

Future Active House is equipped with a KNX BUS control system delivered by In-stell that monitors and manages the building and its equipment. Thanks to this system, occupants of the house can control lighting, heat, ventilation and other functions from practically every room in the house.

All electrically operated equipment can be controlled by touch panels or by network units like smart phones and tablets. This opens almost unlimited possibilities in terms of making the functions of the house fit the residents' preferences.

Building management can be streamlined, light levels can be adjusted and saved, and temperature and air quality can be measured and optimised. Whether residents want comfort, design or simplicity, the Future Active House control system can meet their needs.

The KNX system allows the user to override automatic control. They are not forced to have an open window just because the system tells them to. The objective is to enable the user to choose between fully automatic control and manual control.

Traditional light switches and dimmers are replaced with control boards around the house. The system is installed with default scenarios to regulate light levels, ventilation, heating and sun screening. All default levels can, of course, be adapted to the residents' preferences.

The KNX system is a communication network in which sensors (light and motion sensors, weather stations, thermostats, etc.) send messages to actuators like motor valves, relay modules and dimmers, which perform the required actions. The system is connected with a two-wire cable (BUS) which transmits information and can also work as additional power supply.

Other KNX features in Future Active House include:

- fire alarm integration
- Master Switch features at both front doors and in the main sleeping room, allowing the residents to switch all lights in the house off or on at the same time
- automatic lowering of the temperature and switching ventilation system to minimum when residents leave the house. The settings can be customised by the residents
- fire switch that makes it easier to start the fire in the wooden stoves by increasing the draft
- hot-room controller with integrated thermostat in all rooms
- outdoor lighting equipped with photocell and temperature sensor to display outdoor temperature in all rooms
- automatic water shut-off, with 4-hour delay, when the functions "gone" or "vacation" are activated.



KNX

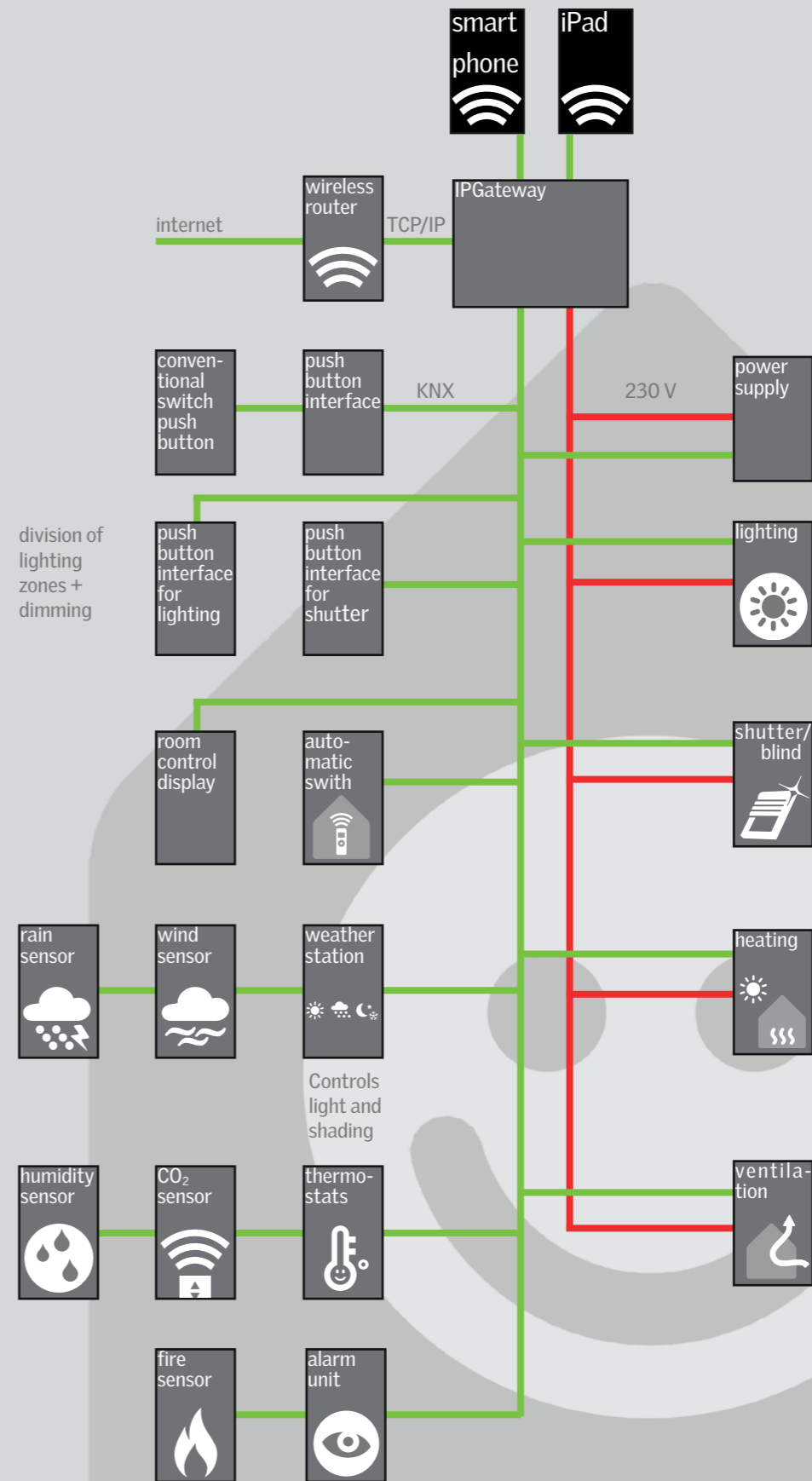

Daylight: Let the sun inside

Future Active House is designed with an eye on optimal daylight conditions. Generous amounts of daylight can improve the living environment in a building but has other benefits too; it reduces the need for electrical lighting, thereby saving energy.

In Future Active House, large windows ensure excellent light conditions in all ground level rooms. On the first floor, the main room has four facade windows and four roof windows. Architect Geir Brendeland is delighted that Future Active House manages to combine energy efficiency with extensive use of windows:

"Daylight is very important. It is great to be able to create a room lit by daylight the entire day and with views to all four corners of the world."

He believes the daylight will add to the residents' daily life: *"Having breakfast in a beautifully sunlit house is just great. Windows allow us to be in contact with the surroundings: the weather, the birds, the clouds."*



Daylight factor

Facts

The daylighting performance of Future House of Norway has been specified using the daylight factor (DF) as performance indicator.

The daylight factor is a common and easy-to-use measure for the available amount of daylight in a room.

It expresses the percentage of daylight available inside, on a work plane, compared to the amount of daylight available outside the building under known overcast sky conditions. The higher the DF, the more daylight is available in the room. Rooms with an average DF of 2% or more are considered day-

lit. A room will appear strongly daylit when the average DF is above 5%. The daylight factor analysis has been performed using computer simulations of radiance. The figures below are showing the daylight factor levels on each floor and the impact of the installed roof windows.

Daylight Factor %

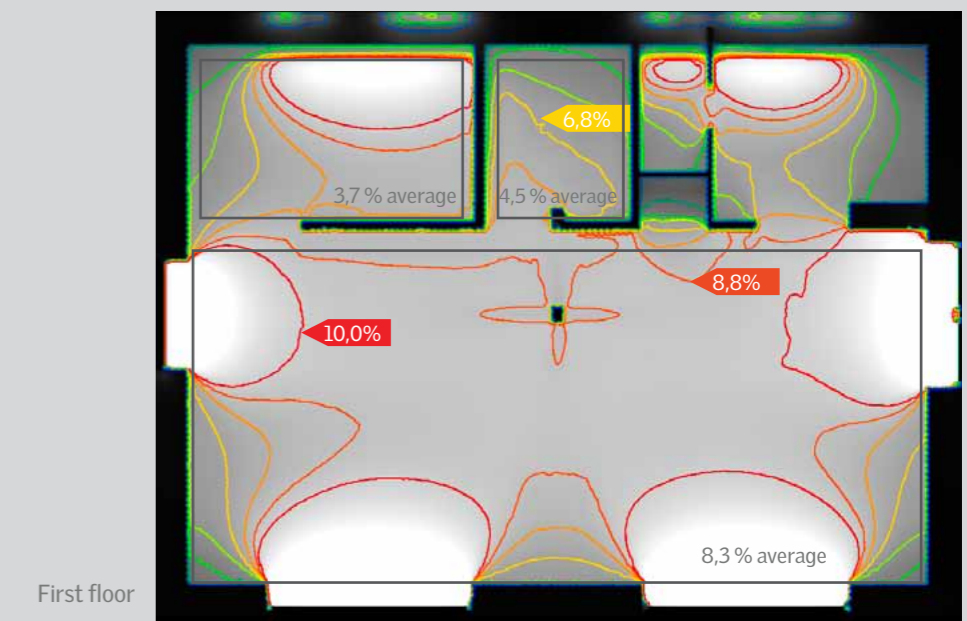
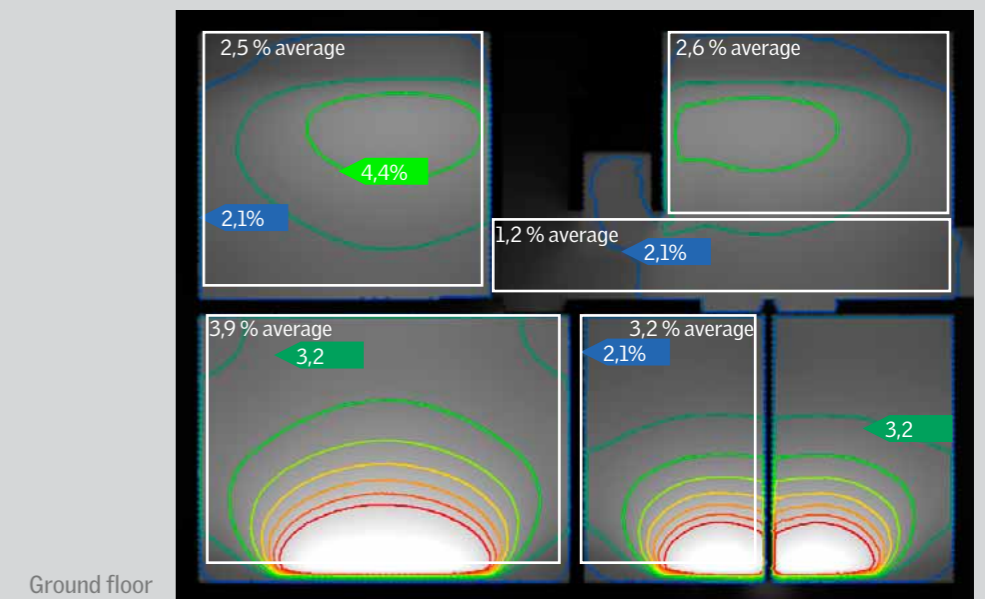

Materials, products

Future Active House is influenced by old construction techniques. At the same time, new materials and detailed arrangements point to the future. Windows and solar collectors are significant elements of the active house. The building as a whole demonstrates that you are free to choose from a range of different materials, even when you build a low-energy and environment-friendly house.

Basement, foundations

The walls are constructed of Leca Isoblocks, which are traditional lightweight concrete blocks with an extra 10 cm of insulating material in the centre of the blocks. In addition, there is a 50 mm drainage system made of expanding polystyrene on the outside of the wall. The basement walls of the active house have a U-value of 0.14. The basement floor is made of concrete insulated with 20 cm of expanding polystyrene (isopor).

Exterior walls

The exterior walls of the active house have a U-value of 0.12. They are constructed with the usual framework, but are considerably thicker than normal walls. From the interior and outwards:

16 mm wooden planks, 5 cm of Glava, vapour barrier, 20 cm of Glava Extrem, 3-5 cm of bitumen plates, layer of cross-beams laid horizontally, another 5 cm of Glava, layer of cross-beams laid vertically, 5 cm of Glava, wind insulation, and external wood panelling.

Glava glass wool is a very good non-hygroscopic insulator that does not absorb water by capillary action and that retains its dimensional stability. Mineral wool is one of the materials with the lowest radon radiation.

Roof:

The roof construction forms a unique pyramid shape. This shape, combined with roof windows and full ceiling height indoors, makes a spectacular second floor full of daylight and spatiality. The pyramid shape is an exceptional idea from the architects, who have combined Norwegian traditional construction techniques with an experimental form.

The roof has a U-value of 0.10 and is well insulated with 500 mm of Glava Extrem laid in four different layers, eliminating thermal bridges. There is a wind barrier outside and vapour barrier inside.

Roof cladding

The roofing is made of zinc cladding supplied by Rhein-zink. This solution is relatively expensive, but highly resistant and does not require maintenance for 60-70 years. Zinc will reflect the light and the surroundings. This special roof was chosen to show alternative solutions and inspire to new ideas. The example shows that you are free to choose from different materials even if you build a low-energy and environment-friendly house.

Roof security equipment is delivered by Lobas.

Roof Windows - VELUX Norge AS

Roof windows ensure good daylight and support natural ventilation. GGU S06 electrically-operated roof windows with 3-layer panes were installed.

The VELUX roof windows have a U-value of 1.0. Roof windows play a very important role in an active house. They ensure good daylight and ventilation.

Screens for roof windows - VELUX Norge AS

All roof windows are equipped with external screening (MML) to avoid overheating on hot days and with internal screening (DML) to reduce heat loss on cold days.

On sunny spring and autumn days, the solar heat will enter through the roof windows and heat the house. When the sun sets in the evening, the temperature in the house will be lowered. This is detected by the sensors, which automatically lower the internal screening on the roof windows to reduce heat loss. The screening is transparent, so daylight influx is not impaired.

Facade windows, doors

Facade windows, balcony door and entrance door are supplied by NorDan (www.nordan.no). They are all of passive house standard with a U-value of 0.7. Since the window area is relatively big in order to ensure good daylight, the U-value of the windows is very important.

Screens for vertical windows:

The windows facing south are equipped with screens from Celsius (4 pieces. ZIP SCREEN - TYPE Celsius 95 mm with engine, aluminium tape, board rails and fabric Zipper System) that keep out almost 90% of the solar heat on hot days. This is important to avoid overheating of the house. The screens are electrically and automatically operated just like the roof windows. As the U-value is as low as 0.7, the windows are not equipped with internal screens to reduce heat loss. The system is designed for strong wind load. Automation supplied by SOMFY.

Garage doors and entrance doors

The house has a double garage with doors at both ends. There are glass doors at both ends in the entrance area. All is delivered by Hörmann.

Wood stoves

The house is equipped with two fireplaces. A free-standing wood stove on the ground floor and a build-in fire insert on the first floor. Both fireplace solutions are delivered by Jøtul. Wood stoves are an environment-friendly alternative heating source (CO₂ emission 10%, emission of dust < 20 mg/Nm³, thermal output 5kW, energy efficiency 82%)

A stand-alone wood stove has small dimensions that make it very easy to place. The unique look is created by Hareide Design. The side windows of the wood stove provide an extra good view of the flames. It is user friendly with only one vent controlling both the lighting and primary air.

Heat recovery unit - Swegon

The heat recovery unit is delivered by Swegon (CASA R120): an air handling unit with rotary heat exchanger, airflows up to 430 m³/h, maximum air flow of 120 l/s. It recovers more than 80% of the heat from the exhaust air.

There is a separate exhaust air connection for the kitchen hood and exhaust air does not pass through the heat exchanger. It is controlled from a control panel, delivers balanced ventilation with heat recovery and provides a good solution for hybrid ventilation in an active house.



Heater - Oso

The heater supplies both hot tap water and floor heating in the bathroom and hallway.

Electrical equipment

Plugs and miscellaneous materials for electrical installations are supplied by Schneider Electric.

There is a large number of plugs installed in the house, so electrical components can be used virtually anywhere without the need for extension cords.

Building control system

The building control system is delivered by Instell - KNX BUS. KNX allows the occupants to control all lighting, heat, ventilation, light levels, sunscreens, etc. from every room in the house. It also regulates light level, ventilation level, space heating, sun screening, opening/closing of windows and at home/out/night functions.

Electrical installations

Vintervoll is responsible for design and execution of electrical installations.

Vacuum cleaning system

IPC Foma Rørteknik supplies an integrated vacuum cleaning system in the house.

Interior finishes:

Indoor lighting - All lighting in the active house is based on LED light delivered by SG.

Kitchen and bathroom fittings

Sigdal Gautwik delivers stone slabs for the kitchen countertop.

Internal doors / sliding doors - Scanflex

Wooden flooring - Kjeldstad trelast - Gilstad gulv

Wall wooden panels - Kjeldstad trelast. All inner walls are covered with 14 X 70 mm spruce panels, stained with white pigments.

Tiles for walls and floor Norfloor: tiles for bathroom walls and a small wall in the kitchen; Italian Appiani, Snow 10 x 40 tiles for bathroom floor and hallway floor; Italian Appiani, Metallica - 04 Bronzo 2.5 x 2.5.

Paints wooden floors and stairs (Oxan - 40 NCS-S 0804-Y30R Jotun), ceilings (white Sens Jotun 02), basement (white Jotaproff 07 pva)

Bathtub delivered by Interform

Water mixers - delivered by Oras

Internal and exterior stairs - Tydal Trappfabrikk



Wooden roof construction delivered by Kjeldstad Trelast

Facts

Ground floor height	2.70 m
Upper floor height	2.20 - 4,8 m
Roof pitch	27°
Footprint	165 m ²
Ground floor useable living area	68 m ²
Upper floor useable living area	68 m ²
Terrace area	68 m ²
Hall and garage	12 m ² + 38 m ²
Plot area	408 m ²
Wall system:	wooden frame construction
Door blower test	0.3



more information and pictures about building process at the web site <http://www.framtidensaktivhus.no>

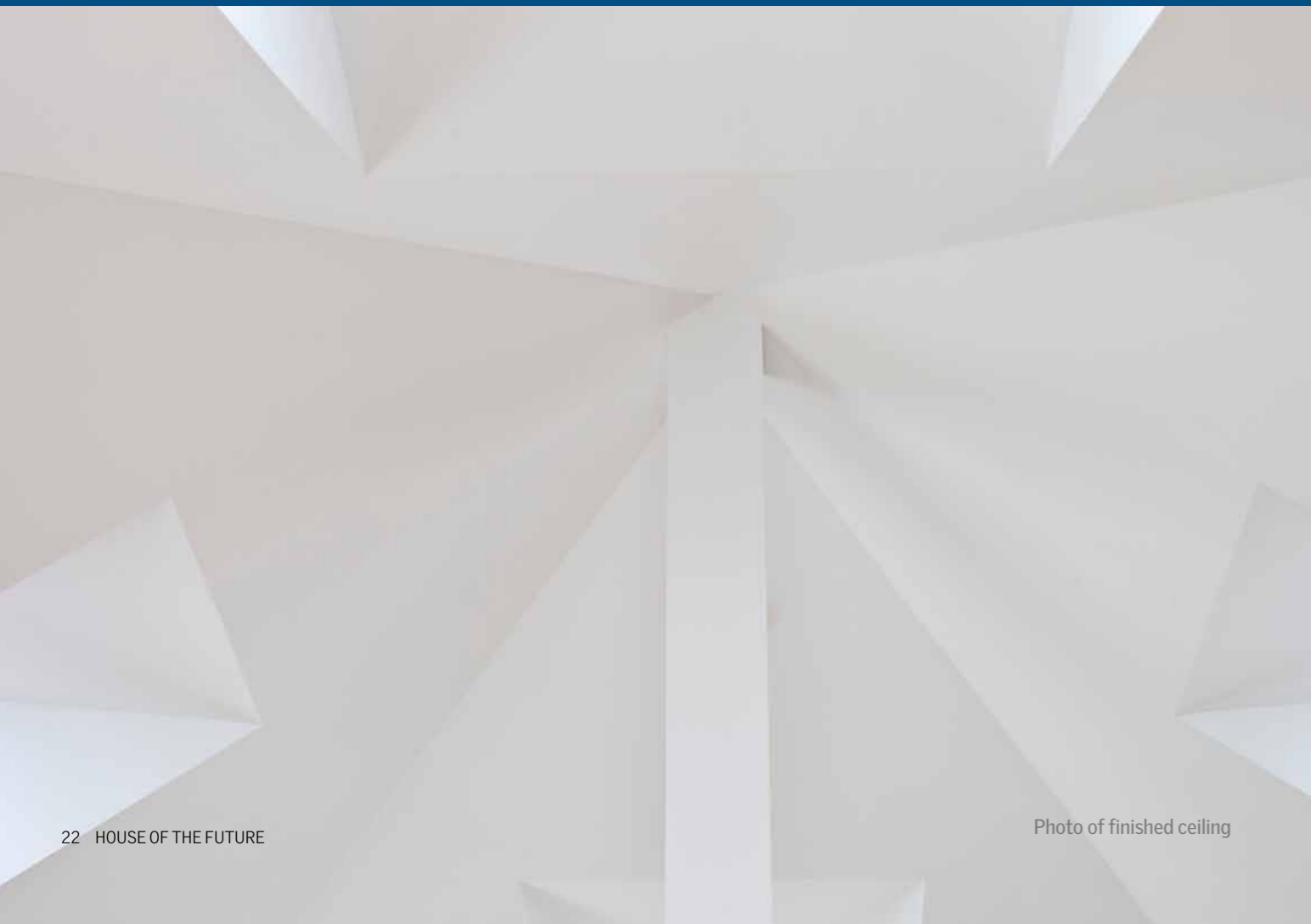

Photo of finished ceiling



Healthy indoor climate: A crucial quality

As citizens in modern societies, we tend to spend most of our time indoors. The air quality in our homes and workplaces affects us on a daily basis and many people consider a good indoor climate to be a crucial quality of a home – a consideration manufacturers of energy-efficient houses must pay attention to, according to professor Anne Grete Hestnes of NTNU, the Norwegian University of Science and Technology.

– *"I think many house buyers are worried about the air quality," says professors A. G. Hestnes who considers Future Active House to be a promising project.*

– *"I think it is very important to show that qualities like air and light are compatible with energy-efficient buildings"*



Interior: Flexible simplicity

The interior of the Future Active House is designed to be light, simple and flexible. The rooms are big and the walls are either white or covered with wood panels of light spruce. According to Future Active House architect, Geir Brendeland, the wood panels have many excellent properties:

– *"Wood is a renewable, natural material that creates a good atmosphere. It speaks to people in a very emotional way. If you touch it, it feels warm, and it has a distinct scent,"* says Geir Brendeland.

Another initiative aimed at strengthening the atmosphere of the house is the fireplaces. They contribute to the heating of the house, but have other advantages too:

"The decision to put in two fireplaces, one on each floor, is not just about heating. Open fire is cosy and adds to the mood," says Richard Ligård, Project Manager of Future Active House.

Geir Brendeland is also fond of fireplaces. They are part of his vision of a house

combining the best from the past and the present:

– *"It is important to integrate basic human needs in a house full of new technology. The qualities of fireplaces are easy to understand for everyone, but perhaps even more when you live in the far north,"* says architect Geir Brendeland.



Exterior: Black and bright

Tradition meets ambition on the outside of the Future Active House. Tradition is visible in the shape of black wood covering most of the facades. The ambition shines through in the solar thermal collectors; their contribution minimises the need for electrical heating of water

– *"The wood cladding is dark, as are the solar collectors. It works quite well visually,"* believes architect Geir Brendeland. He sees the wood cladding as fitting perfectly into the Future Active House's strategies of paying tribute to tradition and making use of local expertise:

– *"The chosen wood cladding is common in Norway. Our company uses it a lot. It is a reference to existing building techniques, it is cheap and local carpenters have a lot of experience with this material,"* says Geir Brendeland.

"The inside of the garden wall is painted in very bright pastel colours in order to highlight the movements of the sunlight during the day. Future Active House is located in a spectacular landscape – but the house and garden are designed to fit into a densely-populated urban environment," explains architect Geir Brendeland.

"When you are down on the ground level and in the garden, the surroundings, neighbours and traffic become invisible. But you can still sense the landscape. If you move to the terrace on the first floor, you are in contact with the surroundings again. It is two very different spaces, but on the same relatively small site."

He points out that the exterior creates many opportunities for the home owners:

"In the summertime, the residents can move around between the garden and the terrace. Also, the doors between the driveway and garden can be opened. When they are closed, the children have a perfectly safe playground," says Geir Brendeland.

Both the architect and the project manager Richard Ligård make it clear that the family who will one day take over the house, can make their own choices regarding their life in Future Active House:

"They can use the rooms and surroundings exactly as they like. It is their property," states Ricard Ligård.



Environment: Local solutions

According to the Active House specification, buildings should have as little environmental impact as possible. The use of local materials reduces the need for transport and on-site processing. Furthermore, it is part of the vision that the environment-friendly house must be easily adapted to regional conditions. So the construction of Future Active House was in the hands of local businesses.

"We deliberately chose local builders and suppliers in order to get the local construction business involved in the project," explains Project Manager Richard Ligård, adding:

"It has been a labour of love to introduce the idea of the Future Active House to the businesses. People have been very supportive and creative."

Richard Ligård sees the Future Active House as a necessary initiative in order to prepare the construction business for the future:

"There is growing political attention to the energy issue everywhere. I am sure we will see tougher legislation in the future."

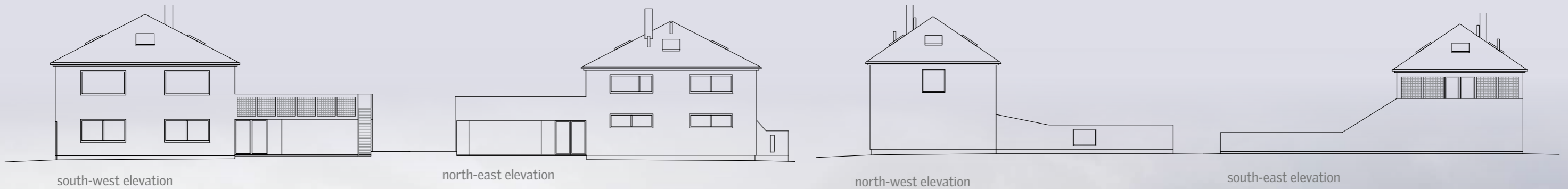

Future Active House as a necessary initiative in order to prepare the construction business for the future:

Performance: Two years of monitoring

In order to evaluate the efficiency of Future Active House and its equipment, energy consumption data and other performance measures will be collected the first two years when the house is occupied. Professor Anne Grete Hestnes, who acted as consultant in the construction phase, highlights the importance of evaluating different aspects of the Future Active House:

- The house is meant to be an energy-efficient building, so we need to prove that it is actually the case. Finally, it is important to ask the residents about their experience with the control system, she concludes.

Future: Experiences to be applied

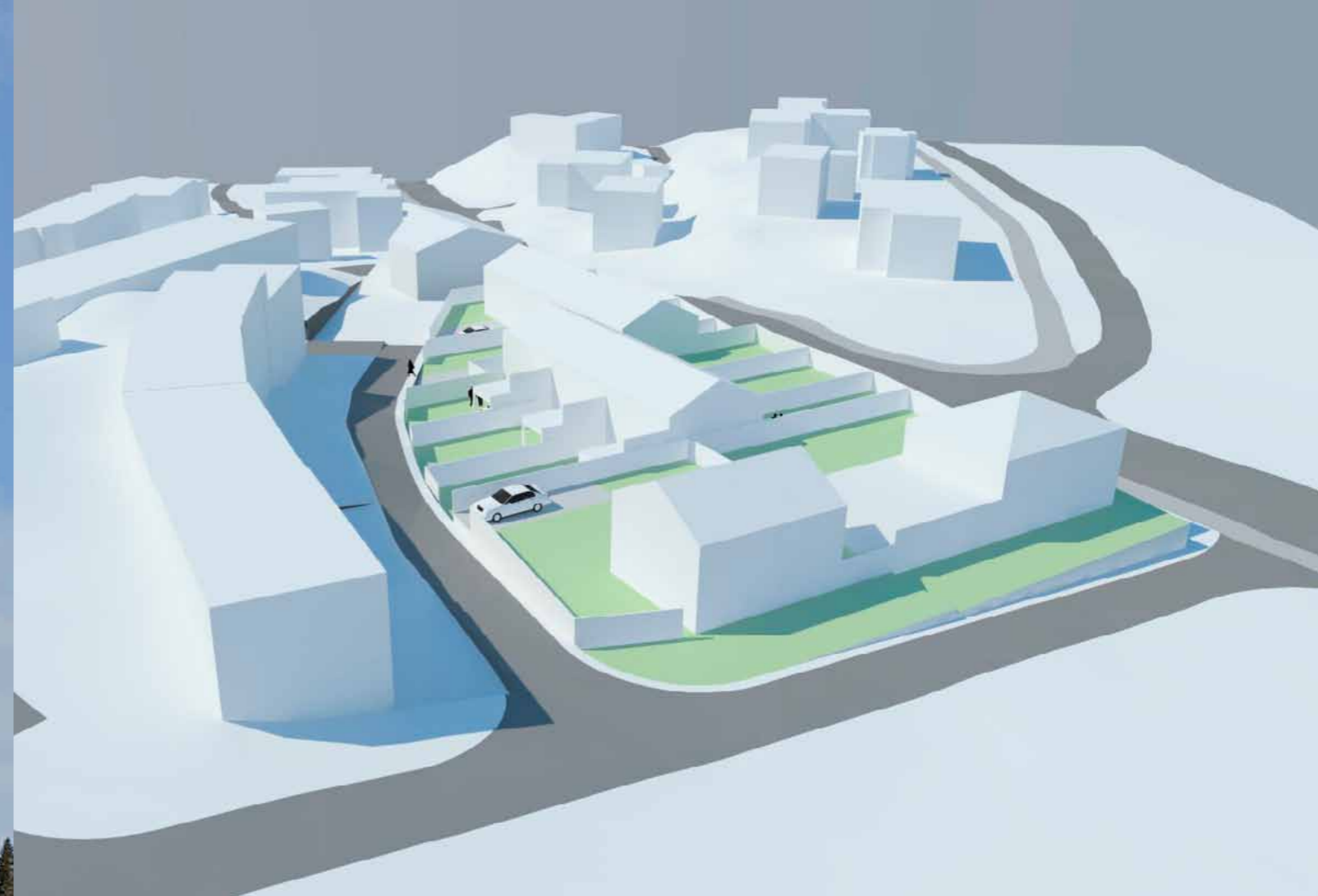

Future Active House will not be short of good neighbours. Richard Ligård, Managing Director of Framtidens Aktivhus as, the company behind the Future Active House, will put the lessons learned from the energy-efficient building to good use:

"All the experience we have gained will be taken into account when we plan the new house – a neighbour to the Future Active House. We also plan to build six townhouses on the site and the experience from Future Active House will benefit the new constructions."

But he believes that the solutions being tested in Future Active House are not just applicable to new buildings:

"Solar collectors and roof windows can improve indoor climate in existing buildings too. So can additional insulation and windows with a lower U-value. Even old and badly maintained buildings can become energy-efficient if the right changes are made and solutions applied. So our project is very relevant for existing buildings too."

Part of the Future Active House vision is to show the wider public that energy-efficient buildings are not just experimental constructions – they can actually be attractive, modern homes. That vision is already partly fulfilled," says Richard Ligård.

"All the attention we are getting on this project shows that the interest for environment-friendly houses definitely exists."

Partners

Tore Ligaard ^a_s



Main contributors



Project development

Architecture:

Brendeland & Kristoffersen Arkitekter

Roof construction:

Kjeldstad trelast, Tor Kjeldstad

Ventilation system:

Aas Luftbehandling as

Tom Werner Aas

Energy consultancy:

Teknoconsult Johnny Holst

NTNU

Professor Anne Grete Hestnes

Construction company:

SSBygg as

Roger Lillebo

Project management

Project manager:

Richard Ligard

VELUX A/S

BI - Building Industry

Producers and suppliers

VELUX Norge AS

NorDan

Hörmann

Rheinzink

Lobas

Leca & Weber Norge

Jøtul

Swegon

Sigdal

Kjeldstad trelast

Byggmakker Aasen & Five

Instell

SG

Scanflex

Glava

Oso

Celcius

Jotun

Norfloor

Gautvik stenindustri

Interform

Schneider Electric

Tydal Trappefabrikk

IPC Foma

ORAS

More information on:
www.framtidensaktivhus.no